



Owner's Manual

This manual contains important safety instructions for gasoline generator models: G5000S, G8000S that should be followed during installation and maintenance of the generator and batteries.

READ SAFETY WARNINGS AND OPERATING INSTRUCTIONS CAREFULLY, SAVE THESE INSTRUCTIONS.

Contents:

- 2-3 STANLEY Product Lines
- 3 Missing Parts Request Form
- 4 Warnings
- 5 Warnings and Specifications
- 6-7 Component Identification
- 8 Wheel Kit Installation & Battery Commissioning
- 9 Controls
- 10-11 Operating the Generator
- 12 Maintenance
- 13 Maintenance, Transporting and Storage
- 14-15 Troubleshooting
- 16 Warranty and Service



**DO NOT RETURN THIS GENERATOR
TO THE STORE**

HAVE QUESTIONS OR NEED HELP?

call our help-line: [1] 919-550-3259

or go to www.portablegenerator911.com or www.GXiOutdoorPower.com

Have the following information ready when you call us:

Date of Purchase: _____

Location of Purchase: _____

Serial #: _____

For more information or where to purchase STANLEY outdoor power equipment, visit us at: www.GXiOutdoorPower.com



Walk Behind Turf and Brush Mowers

- 36" Brush Mower
- HONDA GXV 530 V-twin engine
- Hydro Drive
- Convertible deck—easily converts to a finish mower.

Zero-Turn Commercial Mowers

- 54" and 62"
- HONDA GXV 530 V-twin engine
- Hydro Drive



Commercial Walk Behind Mowers

- 36" and 54" deck
- HONDA GXV 530 V-twin engine
- Belt drive or Hydro Drive

100" Tow Behind Mower

Model: 100TS

- Commercial duty STANLEY tow behind mower
- HONDA GXV 530 V-twin engine cuts up to 100 inches.
- 52 in. brush cut or a 52 in. finish cut mower with wings up.





Electric Pressure Washer

- 1450 psi to 1800 psi electric pressure washers
- 20 ft of high pressure hose and 35 ft. cord with GFCI protection
- Sleek and unique, high quality, stainless steel finish
- 13 Amps, 120V
- Auto-stop shut off system prolongs pump life

Generator Cord Accessories

240V, 10/4, heavy duty extension cords with L14-30 connectors at each end. *This cord reduces harmful voltage drops experienced when using most 120V extension cords.* Available in 15' and 25' lengths and can be combined to reach the desired length.



Missing Parts Request Form

Please indicate the part that you are missing:

- Hardware bag
 Wheel Kit
 Other _____

Date of purchase _____

Model #:

- 5000
 6500
 6500EL
 8000

Serial #: _____

Comments:

_____ Name

_____ Address

_____ Phone

_____ Email

IMPORTANT: Please include a copy your receipt. Without a receipt, your order will be delayed.

E-mail : customerservice@gxioutdoorpower.com
Fax: **1-919-550-3277**

Please scan and attach your proof of purchase to your e-mail.

This owner's manual is considered a permanent part of the generator and should remain with the generator if resold. The information and specifications included in this publication were in effect at the time of approval for printing.

GXi Outdoor Power, LLC, reserves the right to discontinue or change specifications or design at any time without notice and without incurring any obligation whatever. No part of this publication may be reproduced without written permission.

EMISSION CONTROL SYSTEM INFORMATION

The U.S. and California Clean Air Acts

EPA and California regulations require all manufacturers to furnish written instructions describing the operation and maintenance of emission control systems. The following instructions and procedures must be followed in order to keep the emissions from your STANLEY engine within the emission standards. Maintenance, replacement, or repair of the emission control devices and systems may be performed by any engine repair establishment or individual, using parts that are "certified" to EPA standards.

SAFETY LABEL LOCATIONS

These labels warn you of potential hazards that can cause serious injury. Read them carefully. If a label comes off or becomes hard to read, contact your STANLEY generator dealer for a replacement.

SAFETY INFORMATION

STANLEY generators are designed to give safe and dependable service if operated according to instructions. Read and understand this owner's manual before operating your generator.

OPERATOR RESPONSIBILITY

Know how to stop the generator quickly in case of emergency. Understand the use of all generator controls, output receptacles, and connections. Be sure that anyone who operates the generator receives proper instruction. Do not let children operate the generator.



WARNING

The engine exhaust from this product contains chemicals known to the State of California to cause cancer, birth defects or other reproductive harm.



DANGER

CARBON MONOXIDE GAS

Exhaust contains poisonous carbon monoxide, a colorless and odorless gas. Breathing exhaust can cause loss of consciousness and may lead to death. To keep exhaust gas from accumulating, use in an area with adequate ventilation. **DO NOT** use this generator in a garage, basement, crawlspace, enclosed shed, or any other area that does not have adequate ventilation. **DO NOT** use this generator near ventilation ducts or open windows that may allow exhaust gasses to enter your home or business. **ONLY** operate this generator outdoors.



DANGER

Fire and Burn Hazards

The exhaust system gets hot enough to ignite some materials.

- Keep the generator at least 3 feet (1 meter) away from buildings and other equipment during operation.
- Do not enclose the generator in any structure.
- Do not smoke when refueling.
- Keep flammable materials away from the generator.
- The muffler becomes very hot during operation and remains hot for a while after stopping the engine. Be careful not to touch the muffler while it is hot.
- Let the engine cool before storing the generator indoors.
- Refuel in a well ventilated area with the engine stopped.
- Fuel vapors are extremely flammable and may ignite after the engine has started. Make sure that any spilled fuel has been wiped up before starting the generator.



WARNING

Generator must be installed by a qualified electrician and connected to transfer equipment as a separately derived system in accordance with the National Electrical Code, NFPA 70. The generator shall be connected through transfer equipment that switches all conductors other than the equipment grounding conductor. The frame of the generator shall be connected to an approved grounding electrode.

Improper connections to a building electrical system can allow electrical current from the generator to backfeed into the utility lines. Such backfeed may electrocute utility company workers or others who contact the lines during a power outage, and the generator may explode, burn, or cause fires when utility power is restored.

Ground System

STANLEY portable generators have a system ground that connects generator frame components to the ground terminals in the AC output receptacles. The system ground is connected to the AC neutral wire.

Special Requirements

There may be Federal or State Occupational Safety and Health Administration (OSHA) regulations, local codes, or ordinances that apply to the intended use of the generator. Please consult a qualified electrician, electrical inspector, or the local agency having jurisdiction.

This generator does not meet US Coast Guard regulation 33 CFR-183 and should not be used on marine applications.



DANGER

Electrocution hazard - Electricity can cause **DEATH** or **SERIOUS INJURY**.

- Do not operate the generator in standing water.
- This product is not safe to operate when partially or totally submerged in water.
- Ensure proper drainage in the region surrounding this generator.
- Properly ground the generator and verify ground is in place before each use. Grounding regulations vary by location, consult a qualified local electrician for proper grounding instructions.
- Power cords and electrical equipment pose a risk of shock and electrocution, especially if they are operated in wet conditions. Inspect all equipment prior to every use and use only as directed by the manufacturer.
- Use a cord with GFCI protection when using the power outdoors or when moisture is present.
- Generators vibrate in normal use. During and after the use of the generator, inspect the generator as well as extension cords and power supply cords connected to it for damage resulting from vibration. Have damaged items repaired or replaced as necessary. Do not use plugs or cords that show signs of damage such as broken or cracked insulation or damaged blades.

NEVER START OR STOP THE ENGINE WITH DEVICES CONNECTED TO THE GENERATOR.



DANGER

AC Applications

Before connecting an appliance or power cord to the generator:

1. Make sure that appliances are in good working order. Faulty appliances or power cords can create a potential for electrical shock. If an appliance begins to operate abnormally, becomes sluggish or stops suddenly, turn it off immediately.
2. Disconnect the appliance, and determine whether the problem is the appliance, or if the rated load capacity of the generator has been exceeded.
3. Make sure that the electrical rating of the tool or appliance does not exceed that of the generator. Never exceed the maximum power rating of the generator. Power levels between rated and maximum may be used for no more than 30 minutes.

Substantial overloading will open the circuit breaker. Exceeding the time limit for maximum power operation or slightly overloading the generator may not switch the circuit breaker or circuit protector OFF, but will shorten the service life of the generator.

Limit operation requiring maximum power to 30 minutes. For continuous operation (longer than 30 minutes), do not exceed 80% of the rated power balanced equally on the A&B sides of the Alternator.



WARNING

Failure to properly follow maintenance instructions and precautions can cause serious injuries or death. Always follow the inspection and maintenance recommendations and schedules in this owner's manual.

Safety Precautions:

Make sure the engine is off before you begin any maintenance or repairs. This will eliminate several potential hazards:

- **Carbon monoxide poisoning from engine exhaust.**
Be sure there is adequate ventilation whenever you operate the engine.
- **Burns from hot parts.**
Let the engine and exhaust system cool before touching.
- **Injury from moving parts.**
Do not run the engine unless instructed to do so.

In the State of California a spark arrestor is required by law. Other states may have similar laws. Federal laws apply on all federal lands. If you equip the muffler with a spark arrestor, it must be maintained in effective working order. See page 11.

Rapid retraction of the recoil starter cord can pull the starter cord back faster than you can let go. When starting the engine, pull the cord slowly until resistance is felt then pull rapidly to avoid kickback.



DANGER

Changing the speed of the generator by adjusting the governor can cause damage to the generator, devices attached to the generator, and may result in bodily injury. Do not adjust or tamper with the engine speed setting.

Product Specifications

Generator	G5000S	G8000S
Rated frequency	60 Hz	60 Hz
Rated voltage	120V / 240V	120V / 240V
Max continuous output power	5.0 kW (Max.)	8.0 kW (Max)
AC output (Max.)	20.8A	33.3A
Engine type	OHV 4-Stroke	OHV 4-Stroke
displacement	279 cc	401 cc
Compression ratio	8.2:1	8.0:1
Rated rotation speed	3600 RPM	3600 RPM
Rated power	10 Hp	15 Hp
Starting system	Recoil	Recoil and electric starter
Rotation direction	Counter clockwise	Counter clockwise
Fuel type	Unleaded gasoline	Unleaded gasoline
Low oil shutdown	Yes	Yes
Fuel tank size	12 gallons	12 gallons
Oil type / Capacity	SAE 10W-30 0.9 quarts	SAE 10W-30 1.1 quarts
Gross weight	207 lbs (94 kg)	235lbs (107kg)
Battery	N/A	12 AH 12 VDC
Integrated voltmeter	Yes	Yes

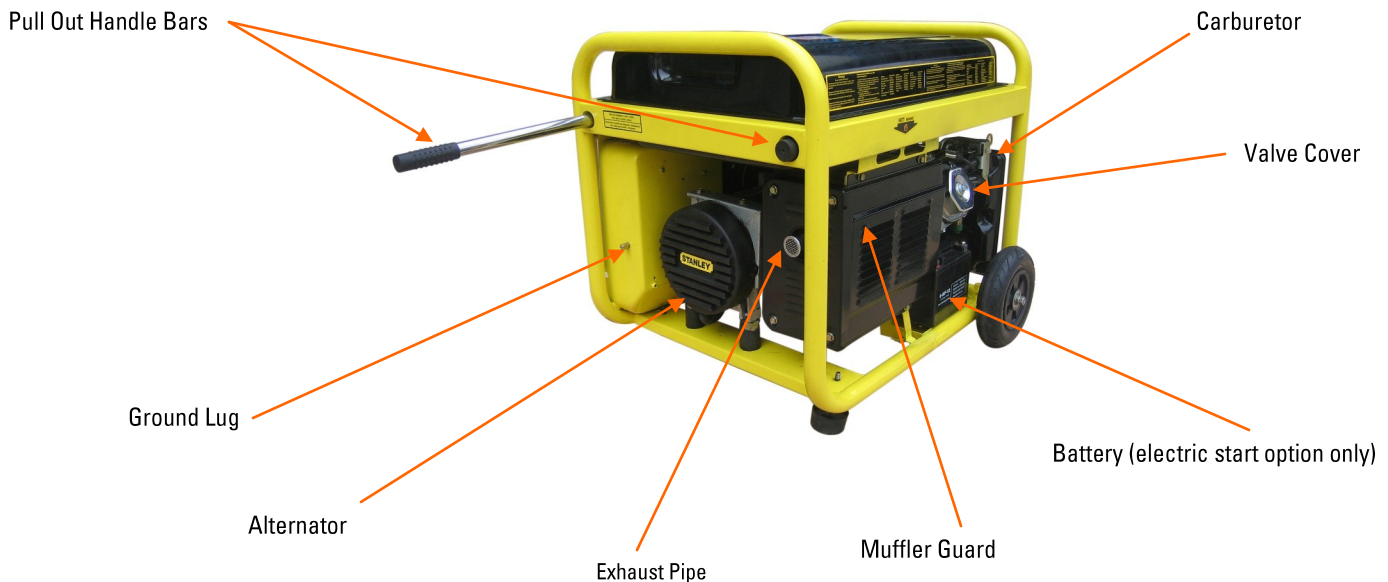
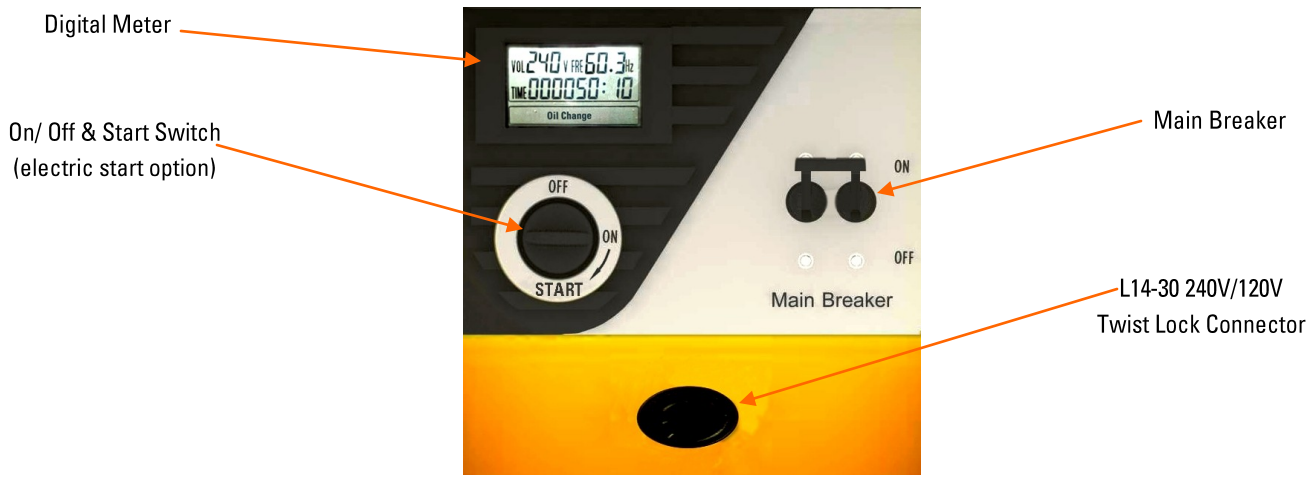



Additional equipment required to safely operate this generator:

1. Gas can.
2. Unleaded gasoline.
3. SAE 10W-30 - 1.1 quarts for STANLEY 11hp, 13hp, 14hp, and 15hp engines, 0.9 quarts required for STANLEY 10 HP.
4. An oil fill funnel.
5. Gasoline fuel stabilizer (for storing your generator).
6. 120V and/or 240V extension cords.
7. An adjustable wrench or a 12mm socket for oil changes.

Note: A spark arrestor was supplied with your generator and must be installed for use within the State of California. See supplemental instructions.

Approximate assembly time is 5 minutes.

Supplied with your generator:

1. Two(2) foot assemblies with two (2) 13 mm nuts.
2. Two (2) wheel axle assemblies.

Two pre-assembled, retractable, handle bars, one on each side of the generator frame. Twist to lock / unlock. Pull or push to extend / retract.

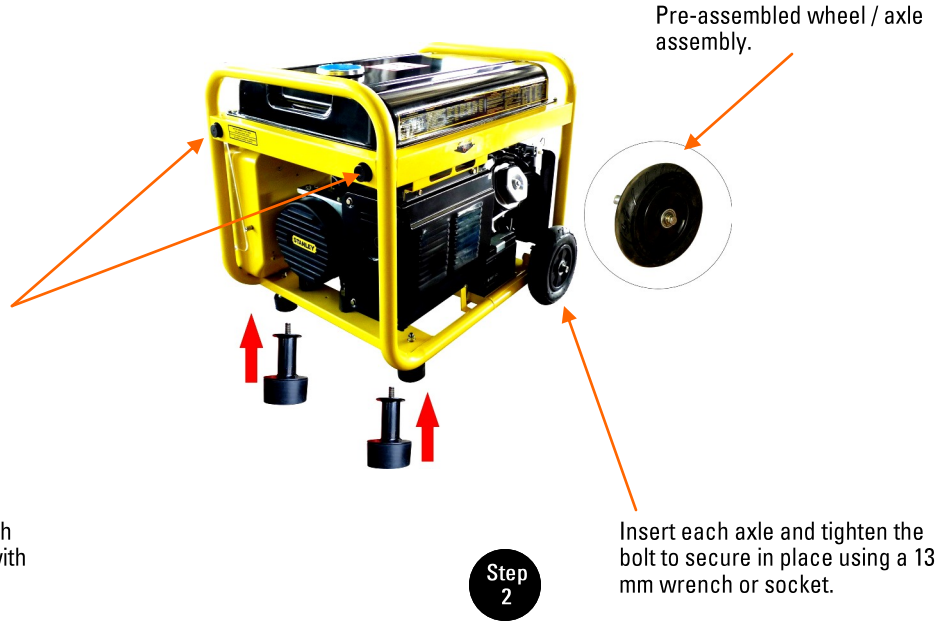

Step 1

Insert each foot assembly through holes in the frame. Tighten nut with 13mm wrench or socket.

Step 2

Insert each axle and tighten the bolt to secure in place using a 13 mm wrench or socket.

Commissioning the Battery

The battery is an optional feature. The battery is used to start a generator equipped with an electric starter. Not all generators are sold with batteries. Please verify with your retailer if you believe the battery is missing.

WARNING

Lead acid storage batteries contain sulfuric acid which can cause serious injuries. The battery also gives off explosive gases. Keep sparks, flames and cigarettes away. Provide adequate ventilation when charging or using batteries. Battery posts, terminals and related accessories contain lead and lead compounds. Avoid spills of electrolyte and wash hands thoroughly after handling. Use gloves and safety glasses when handling and installing lead acid batteries.

If you get electrolyte in your eyes, flush your eyes with clean water for 15 minutes and seek medical attention. Keep out of reach of children.

FOR YOUR SAFETY AND CONVENIENCE, THE BATTERY WAS SHIPPED SEALED AND PRE-CHARGED.

The battery is ready to be connected to the generator.

To connect the battery, use an adjustable wrench or 8 mm socket to secure the BLACK wire to the negative (-) terminal and the RED wire to the positive (+) terminal. Do not allow the wrench to contact any other part of the generator when tightening the battery terminals.



WARNING

The engine was shipped without engine oil. **DO NOT START THE ENGINE WITHOUT FILLING THE ENGINE WITH OIL.** Use SAE 10W-30 for normal conditions and SAE 5W-30 when the ambient temperature is below 32° F.

Choke Rod

The choke is used to provide an enriched fuel mixture when starting a cold engine. It can be opened and closed by operating the choke rod manually. Pull the rod out toward CLOSED to enrich the mixture for cold starting. Open once the engine is running.

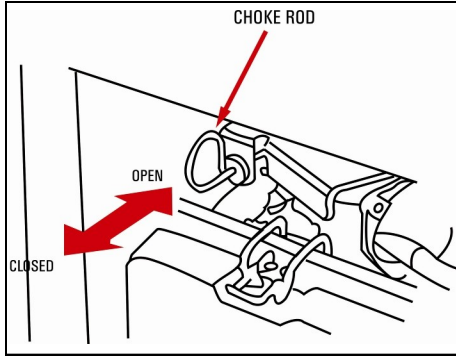

Fuel Valve Lever

The fuel valve is located between the fuel tank and carburetor. When the valve lever is in the ON position, fuel is allowed to flow from the fuel tank to the carburetor. Be sure to return the fuel valve lever to the OFF position after stopping the engine.

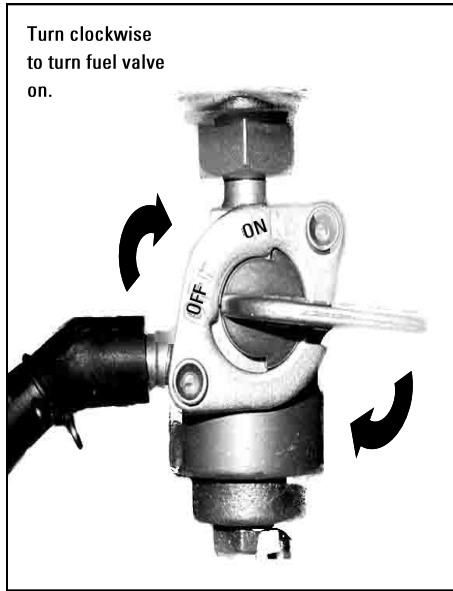

Engine Switch

To start and stop the engine.

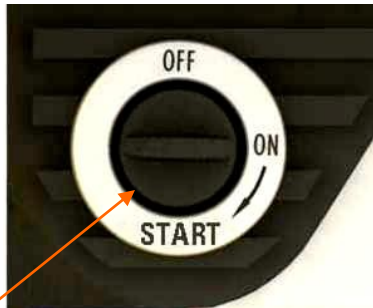

Engine ON / OFF / Start Switch (electric start shown)

Recoil Starter

To start the engine, pull the starter grip lightly until resistance is felt, then pull briskly.

NOTICE:

Do not allow the starter grip to snap back against the engine. Return it gently to prevent damage to the starter.

The recoil starter is used to start the engine if the generator is not equipped with a 12 volt battery to operate the starter motor, or if the battery does not contain adequate charge to operate the starter motor.

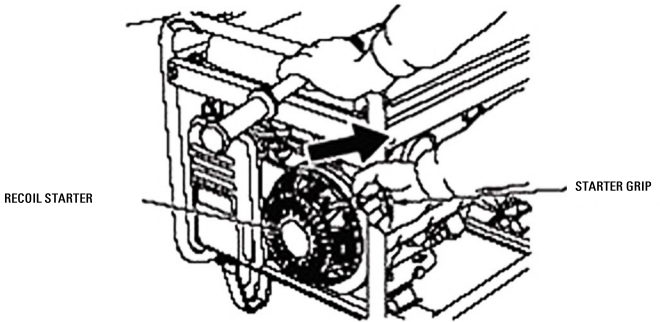

Oil Alert System

The Oil Alert system is designed to prevent engine damage caused by an insufficient amount of oil in the crankcase. Before the oil level in the crankcase can fall below a safe limit, the Oil Alert system will automatically stop the engine (the engine switch will remain in the ON position). The Oil Alert system should not take the place of checking the oil level before each use. If the engine stops and will not restart, check the engine oil level (see page 14) before troubleshooting in other areas.

Ground Terminal

The generator ground terminal is connected to the frame of the generator, the metal non-current-carrying parts of the generator, and the ground terminals of each receptacle.



WARNING

Before using the ground terminal, consult a qualified electrician, electrical inspector or local agency having jurisdiction for local codes or ordinances that apply to the intended use of the generator.

NOTE: SYSTEM GROUND IS CONNECTED TO THE AC NEUTRAL ON THIS GENERATOR. CONSULT AN ELECTRICIAN WHEN CONNECTING THIS GENERATOR TO YOUR HOME OR BUSINESS ELECTRICAL PANEL TO ENSURE GROUNDING MEETS THE LOCAL ELECTRICAL CODE

! DANGER

CARBON MONOXIDE GAS

Using a generator indoors **CAN KILL YOU IN MINUTES.**

Generator exhaust contains carbon monoxide (CO). This is a poison you cannot see or smell. If you can smell the generator exhaust, you are breathing CO. But even if you cannot smell the exhaust, you could be breathing CO.

NEVER use a generator inside homes, garages, crawl-spaces, or other partly enclosed areas. Deadly levels of carbon monoxide can build up in these areas. Using a fan or opening windows and doors does **NOT** supply enough fresh air.

ONLY use a generator outside and far away from windows, doors, and vents. These openings can pull in generator exhaust.

Even when you use a generator correctly, CO may leak into the home. **ALWAYS** use a battery-powered or battery-backup CO alarm in the home.

If you start to feel sick, dizzy, or weak after the generator has been running, move to fresh air **RIGHT AWAY**. See a doctor. You could have carbon monoxide poison.

! DANGER

Electrocution hazard - Electricity can cause **DEATH** or **SERIOUS INJURY**.

- Do not operate the generator in standing water.
- This product is not safe to operate when partially or totally submerged in water.
- Ensure proper drainage in the region surrounding this generator.
- Properly ground the generator and verify ground is in place before each use. Grounding regulations vary by location, consult a qualified local electrician for proper grounding instructions.
- Power cords and electrical equipment pose a risk of shock and electrocution, especially if they are operated in wet conditions. Inspect all equipment prior to every use and use only as directed by the manufacturer.
- Use a cord with GFCI protection when using the power outdoors or when moisture is present.
- Generators vibrate in normal use. During and after the use of the generator, inspect the generator as well as extension cords and power supply cords connected to it for damage resulting from vibration. Have damaged items repaired or replaced as necessary. Do not use plugs or cords that show signs of damage such as broken or cracked insulation or damaged blades.

! WARNING

NEVER START OR STOP THE ENGINE WITH DEVICES CONNECTED TO THE GENERATOR.

Step 1.

Ensure all electrical loads are removed from the generator. Disconnect all the extension cords and ensure the main breaker is in the OFF position. Remove all flammable materials and debris from the area. Make sure the generator is level.

Step 2.

Check the oil level.

- Put the generator on a level surface with the engine stopped.
- Remove the oil filler cap.
- Check the oil level. If the oil level is low, fill it until the oil is overflowing. It will take approximately 0.9 - 1.5 quarts of oil depending on the model of generator.

If additional oil is need, SAE 10W-30 engine oil is recommended for most general purpose applications. In cold weather climate, use SAE 5W-30.

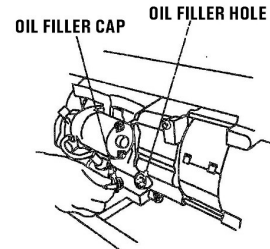
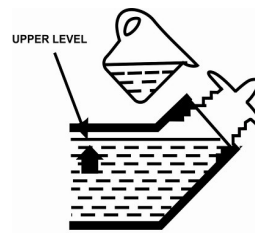

Step 3.

Make sure there is fuel in the gasoline tank. Look at the fuel level indicated by removing the fuel cap to inspect the contents of the fuel tank. The fuel filter can also be inspected once the fuel cap is removed. Ensure the fuel filter is clean of dirt and debris. Tightly secure the fuel cap after your inspection is complete.

Fuel can damage paint and plastic. Be careful not to spill fuel when filling your fuel tank. Damage caused by spilling fuel is not covered under warranty. Use unleaded gasoline with a pump octane rating of 86 or higher. This engine is certified to operate on unleaded gasoline. Unleaded gasoline produces fewer engine and spark plug deposits and extends exhaust system life. Never use stale or contaminated gasoline or an oil/gasoline mixture. Avoid getting dirt or water in the fuel tank.

FUEL STRAINER SHOULDER

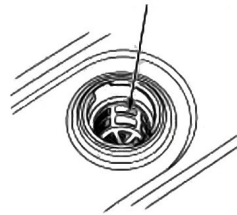

! WARNING

DO NOT overfill the tank. Leave a 1 inch air gap in the tank. Gasoline is highly flammable and explosive. You can be burned or seriously injured when refueling.

- Stop engine and keep heat, sparks, and flame away.
- Refuel only outdoors.
- Wipe up spills immediately.

This portable generator is not for use with gasoline/ethanol blends with over 15% ethanol.

Step 4.

Set the fuel valve lever to the ON position by rotating it clockwise.

Step 5.

Pull the choke lever to the CLOSED position. See page 7 for a diagram of the choke lever.

Step 6.

Turn the generator ON/OFF switch to the "ON" position.

Step 7.

Start the engine

1. If you have an electric starter, turn the switch to the START position, hold it there for 5 seconds and let it come to rest in the ON position once the engine has started.
2. If you are using the recoil starter, pull slightly on the cord until you feel some pressure. Once you feel the back-pressure building, rapidly pull the cord.

Step 8.

Once the generator is running, push the choke lever into the OPEN position.

Step 9.

Let the generator warm up for approximately 3 minutes before applying any electrical loads.

Step 10.

Apply loads to the generator one at a time, allowing the generator to stabilize after you add each incremental load. Add the loads with the largest surge power requirement first. This would include refrigerators, air-conditioners, large motors, and pumps. Add smaller loads once the generator has stabilized with the larger loads.

ALWAYS UNPLUG APPLIANCES AND REMOVE ALL ELECTRICAL LOADS BEFORE REFUELING. THEN FOLLOW STEPS 2 - 10.

WARNING

For power outages, permanently installed stationary generators are better suited for providing backup power to the home. Even a properly connected portable generator can become overloaded. This may result in overheating or stressing the generator components, possibly leading to a generator failure.

WARNING

Connecting a load larger than this generator's power rating may damage the circuit breakers, alternator and sensitive appliances.

Continuously loading this generator above 80% of its maximum output power will shorten the life of the generator.

Balance the load evenly between the A and B outlets to maximize the output power.

Appliances with electric motors require an **additional 150% power when they are starting up** (indicated by an * and in bold in the following chart).

To determine maximum load that you may safely connect to this generator:

1. Calculate the maximum continuous power required by adding up the running power of each appliance. The total running power of your appliances cannot exceed the maximum output power of this generator.
2. Calculate the surge power by:
 - i) Adding up the running power of each appliance with an * and in bold below.
 - ii) Multiplying the total by 1.5.
 - iii) Adding this to the total running power calculated in step 1 above.

The surge power requirements of your appliances cannot exceed the surge power rating of this generator.

Typical Residential Loads

Appliance	Running Power
Light bulbs (each)	75 Watts
Stove element (each)	1000 Watts
Microwave	1500 Watts
Coffee maker	700 Watts
Television	750 Watts
VCR	250 Watts
Computer & monitor	800 Watts
Space heater	1500 Watts
Washing machine	1000 Watts
NG clothes dryer	750 Watts
Electric clothes dryer	5500 Watts
Dishwasher	1850 Watts
Water heater	5000 Watts
Electric furnace	5000 Watts
Toaster	1200 Watts
Box fan*	750 Watts
Window A/C - 8000 BTU*	2400 Watts
Central A/C (per ton)*	2800 Watts
Furnace blower*	850 Watts
2 hp well pump*	2000 Watts
Refrigerator*	1000 Watts
Freezer*	1000 Watts

STOPPING THE GENERATOR
In an emergency:

To stop the engine in an emergency, move the engine switch to the OFF position and turn the fuel valve OFF.

In normal use:

1. Turn the AC circuit breaker to the OFF position (if applicable).
2. Disconnect all loads and extension cords.
3. Allow the engine to run with no load for 3 minutes.
4. Turn the engine switch to the OFF position.
5. Turn the fuel valve lever to the OFF position.
6. Allow the generator to cool off before touching any engine or alternator components. It may take as long as 30 minutes before the generator is cool enough to touch safely.

MAINTENANCE

The Importance of Maintenance

Good maintenance is essential for safe, economical, and trouble-free operation. It will also help reduce air pollution.

To help you properly care for your generator, the following pages include a maintenance schedule, routine inspection procedures, and simple maintenance procedures using basic hand tools. Other service tasks that are more difficult, or require special tools, are best handled by professionals and are normally performed by a STANLEY technician or other qualified mechanic.

The maintenance schedule applies to normal operating conditions. If you operate your generator under severe conditions, such as sustained high-load or high-temperature operation, or use it in unusually wet or dusty conditions, consult your servicing dealer for recommendations applicable to your individual needs and use.

Maintenance, replacement, or repair of the emission control devices and systems may be performed by any engine repair establishment or individual, using parts that are "certified" to EPA standards.

Maintenance Schedule

Item	Before each use	20hrs or every 3 month	50 hrs or every 3 months	100 hrs or every 6 months	300 hrs or every 1 year
Engine oil (Check)	X				
Engine Oil (Change)		X			
Air Cleaner (Check)	X				
Air Cleaner Wash			X		
Fuel filter Cup (Clean)				X	
Spark Plug (Clean)				X	
Spark Plug (Change)					X
Optional Spark Arrestor (Clean)			X		
Valve Clearance (Adjust)					X*
Fuel Tank and Filter (Clean)				X*	
Fuel Tube (Check)	Every 2 yrs (replace if necessary)*				
Combustion Chamber (Clean)	After every 250 hrs*				

* Should be performed by an authorized STANLEY service center.

Replacement Parts

The emission control systems on your STANLEY engine were designed, built, and certified to conform with EPA and California emission regulations. We recommend the use of genuine STANLEY parts whenever you have maintenance done. These original-design replacement parts are manufactured to the same standards as the original parts, so you can be confident of their performance. The use of replacement parts that are not of the original design and quality may impair the effectiveness of your emission control system.

A manufacturer of an aftermarket part assumes the responsibility that the part will not adversely affect emission performance. The manufacturer or rebuilder of the part must certify that use of the part will not result in a failure of the engine to comply with emission regulations.

Engine Oil Change

Drain the oil while the engine is warm to assure rapid and complete draining.

1. Remove the drain plug and sealing washer, remove the oil filler cap, and drain the oil.
2. Reinstall the drain plug and sealing washer. Tighten the plug securely.
3. Refill with the recommended oil (SAE 10W-30) and check the oil level.

Dispose of used motor oil in a manner that is compatible with the environment. Do not throw it in the trash, pour it on the ground, or down a drain.

Air Cleaner Service

A dirty air cleaner will restrict air flow to the carburetor. To prevent carburetor malfunction, service the air cleaner regularly. Service more frequently when operating the generator in extremely dusty areas.

NOTICE:

Never run the generator without the air filter. Rapid engine wear will result.

1. Unsnap the air cleaner cover clips, remove the air cleaner cover, and remove the element.
2. Wash the air cleaner element in a solution of household detergent and warm water, then rinse thoroughly, or wash in nonflammable or high flashpoint solvent. Allow the air cleaner element to dry thoroughly.
3. Soak the air cleaner element in clean engine oil and squeeze out the excess oil. The engine will smoke during initial startup if too much oil is left in the air cleaner element.
4. Reinstall the air cleaner element and the cover.

Fuel Filter Cleaning

The fuel filter cup / screen prevents dirt which may be in the fuel from entering the carburetor. The fuel filter should be inspected and cleaned on a regular basis. For best results, clean the filter with gasoline and a toothbrush or blow the debris out of the filter with air pressure.

Spark Plug Service

In order to service the spark plug, you will need a spark plug wrench. Recommended spark plugs: BPR5ES (NGK) and W16EPR-U (DENSO). To ensure proper engine operation, the spark plug must be properly gapped and free of deposits.

If the engine has been running, the muffler will be very hot. Be careful not to touch the muffler.

1. Remove the spark plug cap.
2. Clean any dirt from around the spark plug base.
3. Use a spark plug wrench to remove the spark plug.

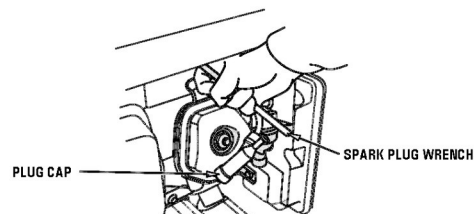

4. Visually inspect the spark plug. Discard it if the insulator is cracked, chipped or fouled.
5. Measure the plug gap with a feeler gauge. Correct as necessary by carefully bending the side electrode. The gap should be: 0.028 to 0.031 in (0.70 to 0.80 mm)
6. Check that the spark plug washer is in good condition, and thread the spark plug in by hand to prevent cross-threading.
7. After the spark plug is seated, tighten with a spark plug wrench to compress the washer.

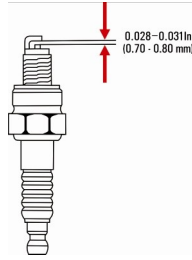

If installing a new spark plug, tighten 1/2 turn after the spark plug seats to compress the washer. If reinstalling a used spark plug, tighten 1/8 to 1/4 turn after the spark plug seats to compress the washer.

NOTICE:

The spark plug must be securely tightened. An improperly tightened spark plug can become very hot and could damage the engine. Use only the recommended spark plugs or equivalent.

Optional Spark Arrestor Maintenance

If the generator has been running, the muffler will be very hot. Allow it to cool before proceeding. **The spark arrester must be serviced every 50 hours to keep it functioning as designed.**

Clean the spark arrester as follows:

1. Loosen the screw by the exhaust port of the muffler and remove the spark arrester.
2. Use a brush to remove carbon deposits from the spark arrester screen. Inspect the screen for breaks or tears and replace it if necessary.
3. Install the spark arrester in the reverse order of removal.

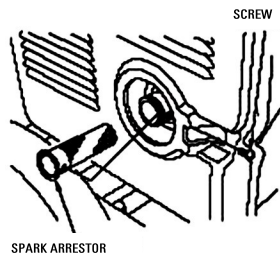

TRANSPORTING

When transporting the generator, turn the engine switch and the fuel valve OFF. Keep the generator level to prevent fuel spillage. Fuel vapor or spilled fuel may ignite.

Take care not to drop or strike the generator when transporting. Do not place heavy objects on the generator. When transporting the generator by loading it on to a vehicle, secure to the generator frame as shown.



DANGER

Contact with a hot engine or exhaust system can cause serious burns or fires. Let the engine cool before transporting or storing the generator.

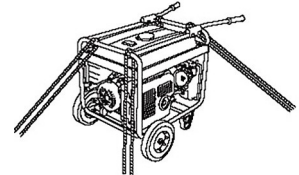

STORING

Before storing the unit for an extended period:

1. Be sure the storage area is free of excessive humidity and dust.
2. Service according to the table below:

STORAGE TIME	Recommended Service Procedure to prevent hard starting:
1 to 2 months	Fill with fresh gasoline and add gasoline stabilizer*.
2 months to 1 year	Fill with fresh gasoline and add gasoline stabilizer*. Drain the carburetor float bowl.
1 year or longer	Fill with fresh gasoline and add gasoline stabilizer*. Drain the carburetor float bowl. Remove the spark plug. Put a tablespoon of engine oil into the cylinder. Turn the engine slowly with the recoil starter to distribute the oil. Reinstall the spark plug. Change the engine oil. After removal from storage, drain the stored gasoline into a suitable container, and fill with fresh gasoline before starting.
* Use gasoline stabilizers that are formulated to extend storage life. Contact your authorized STANLEY generator dealer for conditioner recommendations.	

Storage Preparation

1. Drain the carburetor by loosening the drain screw. Drain the gasoline into a suitable container. Place 4 ounces of fuel stabilizer in the fuel tank.
2. Change the engine oil (page 10).
3. Remove the spark plug, and pour about a tablespoon of clean engine oil into the cylinder. Turn the engine several revolutions slowly with the recoil starter to distribute the oil, then reinstall the spark plug.
4. Slowly pull the starter grip until resistance is felt. At this point, the piston is coming up on its compression stroke and both the intake and exhaust valves are closed. Storing the engine in this position will help to protect it from internal corrosion.



WARNING

Gasoline is extremely flammable and is explosive under certain conditions. Perform this task in a well-ventilated area with the engine stopped. Do not smoke or allow flames or sparks in the area during this procedure.

Symptom:	Potential Causes	Solution
Engine won't start	Fuel valve off/out of fuel	Fill tank with fuel and turn fuel valve on
	Engine Switch in off position	Turn engine switch to on position
	Spark arrestor clogged	Remove spark arrestor, clean and replace.
	Choke is open	Close choke by pulling choke handle out. Open choke after starting.
	Oil level too low	Fill oil to top of opening with recommended grade of oil.
	Oil float stuck in shipment	Fill oil to top of opening, disconnect the yellow wire from the low oil level switch. The switch is located on the engine above the oil drain plug. It is a small gold colored box with a yellow and a black wire. Start the unit and run it for one hour minimum - this will get enough movement of hot oil to free the float if this is the cause. Re-attach the yellow wire and run the unit.
	Fuel filter is dirty	Check for fuel flow to carburetor by removing drain screw. Clean or replace fuel filter.
	Fuel is contaminated	Drain fuel tank and carburetor. Replace or clean filter and carburetor float bowl. Fill tank with clean fuel.
	Spark plug boot off/loose	Press spark plug boot firmly on spark plug.
	Spark plug fouled or failed	Remove spark plug, clean or replace
Carburetor clogged	Remove float bowl and clean components and jets. Replace carburetor if varnish or gum has accumulated from improper storage.	
Recoil is hard to pull	Spark arrestor clogged	Remove, clean and replace.
	Engine flooded with fuel after storage with fuel valve in on position	Remove spark plug and slowly pull recoil to discharge excess fuel. Clean and re-install spark plug.
	Valve clearance too large	Rest exhaust valve clearance to .008", call customer help line.
Engine starts, but then shuts off after running for short time	Remove/Clean spark arrestor	Remove, clean and replace.
	Oil level too low	Fill oil to top of opening with recommended grade of oil.
	Fuel valve off/out of fuel	Fill tank with fuel and turn fuel valve on
	Spark plug fouled or failed	Remove spark plug, clean or replace
Engine runs: rough/vibrating/oscillating	Remove/Clean spark arrestor	Remove, clean and replace.
	The choke is not open	Push choke lever in.
	Over loading generator	Disconnect some appliances
	Air filter is dirty	Clean air filter
	Fuel filter is dirty	Check for fuel flow to carburetor by removing drain screw. Clean or replace fuel filter.
Fuel is contaminated	Drain fuel tank and carburetor. Replace or clean filter and carburetor float bowl. Fill tank with clean fuel.	

Symptom:	Potential Causes	Solution
Engine runs, low speed, bogs down under load or does not maintain 60Hz	Remove/Clean spark arrestor	Remove, clean and replace.
	Choke is not open	Push choke lever in
	Over loading generator	Disconnect some appliances / devices
	Air filter is dirty	Clean air filter
	Fuel filter is clogged	Contaminates will clog filter, not allowing fuel to get to engine
	Fuel filter is dirty	Check for fuel flow to carburetor by removing drain screw. Clean or replace fuel filter.
	Fuel is contaminated	Drain fuel tank and carburetor. Replace or clean filter and carburetor float bowl. Fill tank with clean fuel.
Engine oil leak	Oil fill cap loose or cross threaded	Wipe all oil off unit, remove both oil fill caps, inspect and replace. Tighten securely.
	Oil drain plug loose	tighten both drain plugs
	Debris under oil drain plug gasket	Remove drain plug and debris. Inspect gasket for damage and replace if damaged.
	Loose crankcase bolt(s)	Tighten crankcase bolts
	Valve cover bolt loose	Tighten bolt
	Oil leaking from shaft	Oil seals failed, call customer help line
Fuel leak at tank shut-off	Shut-off valve loose	Tighten nut on shut-off valve/replace shut-off valve
Fuel leaking out of carburetor	Fuel drain screw loose	Tighten fuel drain screw
	Carburetor float seat not seating	Flush with clean fuel
Engine runs, Volt meter shows 0 Volts, no power to outlets	Breaker tripped	Disconnect all loads and turn breaker to off and back to on to reset.
	Disconnected or damaged wiring inside unit	Call customer helpline
Engine runs and volt meter shows 240VAC but no power goes to connected devices	Faulty extension cord/power strip	Use different power strip or extension cord
	Breaker or GFCI tripped on extension cord or power strip	Reset breaker and remove loads from power strip
Voltage too high/low	Engine speed low or high	Verify frequency reading is 58Hz to 62Hz on meter. Call customer helpline if frequency is above 58Hz. See engine speed troubleshooting if engine speed is below 58Hz.
	Alternator damaged	Call customer helpline
	Speed screw damaged or bent	Call customer helpline
Voltage is 120 VAC on 1 phase but too high/low on other phase	Alternator phase is damaged	Call customer helpline

PRODUCTS COVERED BY THIS WARRANTY:	LENGTH OF WARRANTY:*		
	(FROM THE DATE OF ORIGINAL RETAIL PURCHASE)		
	NONCOMMERCIAL/ NONRENTAL	COMMERCIAL	RENTAL
Engine	24 months / 200 hours	6 months / 200 hours	3 months / 200 hours
Battery	3 months	3 months	3 months
Alternator	24 months / 200 hours	6 months / 200 hours	3 months / 200 hours
Electrical and Frame Components	24 months / 200 hours	6 months / 200 hours	3 months / 200 hours
Emission Controls	24 months	24 months	24 months

*LENGTH OF WARRANTY: All warranty coverage except emission controls expires when the operating hours exceed 200 hours.

TO QUALIFY FOR THIS WARRANTY:

The product must be purchased in the United States from a dealer authorized by GXi Outdoor Power, LLC to sell those products. This warranty applies to first retail purchaser / owner during the applicable warranty time period. **SAVE YOUR PROOF OF PURCHASE RECEIPT.**

WHAT STANLEY POWER EQUIPMENT WILL REPAIR OR REPLACE UNDER WARRANTY:

STANLEY will repair or replace, at its option, any part that is proven to be **defective in material or workmanship** under normal use during the applicable warranty time period subject to the exclusions stated herein. This warranty is void if the owner fails to follow the prescribed maintenance and operating procedures described in this manual. This specifically refers to ensuring routine oil changes are made, that fuel stabilizer is used for long-term storage, that the generator is not overloaded, and that the generator loads are distributed evenly between the A and B outlets. Dirty carburetors, spark plugs, air filters, fuel filters, and freight or handling damage are not covered under warranty.

STANLEY has the right to recover warranty administration costs from the owner if the root cause of the malfunction was found to be other than defective material or workmanship. In particular, this warranty does not cover: contaminants in the fuel or oil; damage caused by not following the prescribed warnings and operating practices; failure to follow proper maintenance and storage procedures; and physical damage due to shipping or handling or storage. Damage to the generator that occurs as a result of connecting a STANLEY generator to household wiring without the use of a UL approved transfer switch device that is connected to the home or business and grounded as per applicable local electrical codes, is not covered by this warranty.

Warranty repairs will be made without charge for parts and labor for the first year. After the first year, this limited warranty covers the costs of replacement parts only.

TO OBTAIN WARRANTY SERVICE:

You must take the STANLEY Power Equipment product, accessory, replacement part, apparel or the power equipment on which the accessory or replacement part is installed, and proof of purchase, at your expense, to any STANLEY Power Equipment service location in the United States, who is authorized to service that product, during the service location's normal business hours. If you are unable to obtain warranty service, or are dissatisfied with the warranty service you receive, take the following steps: First, contact the manager of the service center involved; normally this will resolve the problem. However, if you should require further assistance, write or call the STANLEY Customer Service.

EXCLUSIONS:

THIS WARRANTY DOES NOT EXTEND TO PARTS AFFECTED OR DAMAGED BY ACCIDENT AND/OR COLLISION, NORMAL WEAR, FUEL CONTAMINATION, USE IN AN APPLICATION FOR WHICH THE PRODUCT WAS NOT DESIGNED OR ANY OTHER MISUSE, NEGLIGENCE, INCORPORATION OR USE OF UNSUITABLE ATTACHMENTS OR PARTS, UNAUTHORIZED ALTERATION, OR ANY CAUSES OTHER THAN DEFECTS IN MATERIAL OR WORKMANSHIP OF THE PRODUCT. Consumable parts such as oil, spark plugs, filters, carburetors, are not covered by this warranty. You are responsible for transporting your STANLEY product to and from the service center. GXi Parts & Service can arrange for pickup and delivery if the service center provides this service, at your expense.

DISCLAIMER OF CONSEQUENTIAL DAMAGE AND LIMITATION OF IMPLIED WARRANTIES:

STANLEY DISCLAIMS ANY RESPONSIBILITY FOR LOSS OF TIME OR USE OF THE PRODUCT, TRANSPORTATION, COMMERCIAL LOSS, OR ANY OTHER INCIDENTAL OR CONSEQUENTIAL DAMAGE. ANY IMPLIED WARRANTIES ARE LIMITED TO THE DURATION OF THIS WRITTEN LIMITED WARRANTY.

This warranty is void if the manufacturing date and the serial number on the equipment has been removed or the equipment has been modified.

EMISSION CONTROL SYSTEM INFORMATION

The U.S. and California Clean Air Acts

EPA and California regulations require all manufacturers to furnish written instructions describing the operation and maintenance of emission control systems. The following instructions and procedures must be followed in order to keep the emissions from your STANLEY engine within the emission standards. Maintenance, replacement, or repair of the emission control devices and systems may be performed by any engine repair establishment or individual, using parts that are "certified" to EPA standards.

The emission control systems on your STANLEY engine were designed, built, and certified to conform with EPA regulations. We recommend the use of genuine STANLEY parts whenever you have maintenance done. These original-design replacement parts are manufactured to the same standards as the original parts, so you can be confident of their performance. The use of replacement parts that are not of the original design and quality may impair the effectiveness of your emission control system. A manufacturer of an aftermarket part assumes the responsibility that the part will not adversely affect emission performance. The manufacturer or re-builder of the part must certify that use of the part will not result in a failure of the engine to comply with emission regulations.

Emission controls are covered by this warranty for all uses for a period of 2 years from original retail purchase date, this coverage extends to subsequent owners of the product with proof of original purchase. For emissions warranty service call 1-800-393-0668 or e-mail customerservice@gxioutdoorpower.com .